

Centre Number						Candidate Number				
Surname										
Other Names										
Candidate Signature										

For Examiner's Use	
Examiner's Initials	
Question	Mark
1	
2	
3	
4	
TOTAL	



General Certificate of Education  
Advanced Level Examination  
June 2010

## Physics

(Specifications A and B)

## PHA6/B6/X

Unit 6 Investigative and Practical Skills in A2 Physics  
Route X Externally Marked Practical Assignment (EMPA)

### Section B

**For this paper you must have:**

- a calculator
- a pencil
- a ruler
- a small plane mirror
- your completed Section A Task 2 question paper/ answer booklet.

**Time allowed**

- 1 hour 15 minutes

**Instructions**

- Use black ink or black ball-point pen.
- Fill in the boxes at the top of this page.
- Answer **all** questions.
- You must answer the questions in the spaces provided. Do not write outside the box around each page or on blank pages.
- Show all your working.
- Do all rough work in this book. Cross through any work you do not want to be marked.

**Information**

- The marks for questions are shown in brackets.
- The maximum mark for Section B is 24.



J U N 1 0 P H A 6 B 6 X 0 1

WMP/Jun10/PHA6/B6/X

## PHA6/B6/X

**Section B**

Answer **all** the questions in the spaces provided.

The time allowed is 1 hour 15 minutes.

You will need to refer to the work you did in Section A Task 2 when answering these questions.

- 1** In part (a) and part (b) of Section A Task 2 you obtained measurements to determine the mean length,  $c$ , of one paper clip, and  $d$ , the diameter of the wire from which the paper clips have been formed.

It can be shown that  $L$ , the length of the paper clip chain used in part (c) of Section A Task 2, when laid out flat, is given by

$$L = nc - 2d(n - 1),$$

where  $n$  = number of paper clips in the chain.

- 1 (a)** Evaluate  $L$ .

.....

.....

.....

$$L = \dots\dots\dots$$

(2 marks)

- 1 (b)** A student suggests that because  $d$  is much less than  $c$ , the length of the chain can be safely estimated by calculating  $nc$ .  
The student calculates the percentage difference between the calculated value of  $nc$  and the true value of  $L$ , for different values of  $n$ .  
The student's results are shown in **Table 1**.

**Table 1**

$n$	percentage difference
1	0.00
2	2.17
4	3.28
8	3.85
16	4.14
32	4.28
64	4.35

1 (b) (i) Explain why the percentage difference increases as  $n$  increases.

.....

.....

.....

.....

1 (b) (ii) The student suggests that the percentage difference tends towards a constant value when  $n$  becomes very large. Explain with reference to the data in **Table 1**, why the student's suggestion might be correct.

.....

.....

.....

.....

.....

1 (b) (iii) A different student decides that calculating  $nc$  is an acceptable method of estimating  $L$ , providing that the percentage difference is less than 4%. Suggest how the student could use the data in **Table 1** to determine the **largest** value of  $n$  that meets this condition and explain what the student should do so this value of  $n$  is determined accurately. You should illustrate your answer with a sketch.

.....

.....

.....

.....

.....

(5 marks)

Turn over ►

2 A student performs the experiment using apparatus identical to that which you used. The student records the position of **every junction** between paper clips in the chain, starting at the centre of the chain where the 12<sup>th</sup> and 13<sup>th</sup> paper clips are joined, and finishing where the 24<sup>th</sup> paper clip meets the horizontal support at the right-hand end of the chain.

Using all the data measured, the student uses a computer to produce the graph, shown in **Figure 4**.

2 (a) Use **Figure 4** to determine the gradient,  $G$ , at the junction **between the 18<sup>th</sup> and 19<sup>th</sup> paper clips**. You are provided with a small plane mirror which you may use to assist you in answering the question.

.....  
.....

$G =$  ..... (2 marks)

2 (b) The student calculates the length of the chain,  $L$ , and measures the horizontal distance,  $s$ , between the ends of the paper clip chain. The student's results are  $L = 1.17$  m and  $s = 0.756$  m.

Using your result for  $G$  and the student's values for  $L$  and  $s$ , evaluate

2 (b) (i)  $p$ , where  $p = \frac{L}{4G}$ ,

.....  
.....

2 (b) (ii)  $q$ , where  $q = \frac{s}{2p}$ .

.....  
..... (1 mark)

2 (c) The sag,  $r$ , is the vertical distance between the point of suspension and the bottom of the chain.

Evaluate  $r$ , where  $r = \frac{p}{2} (e^q + e^{-q} - 2)$ .

.....  
..... (2 marks)

**Figure 4**

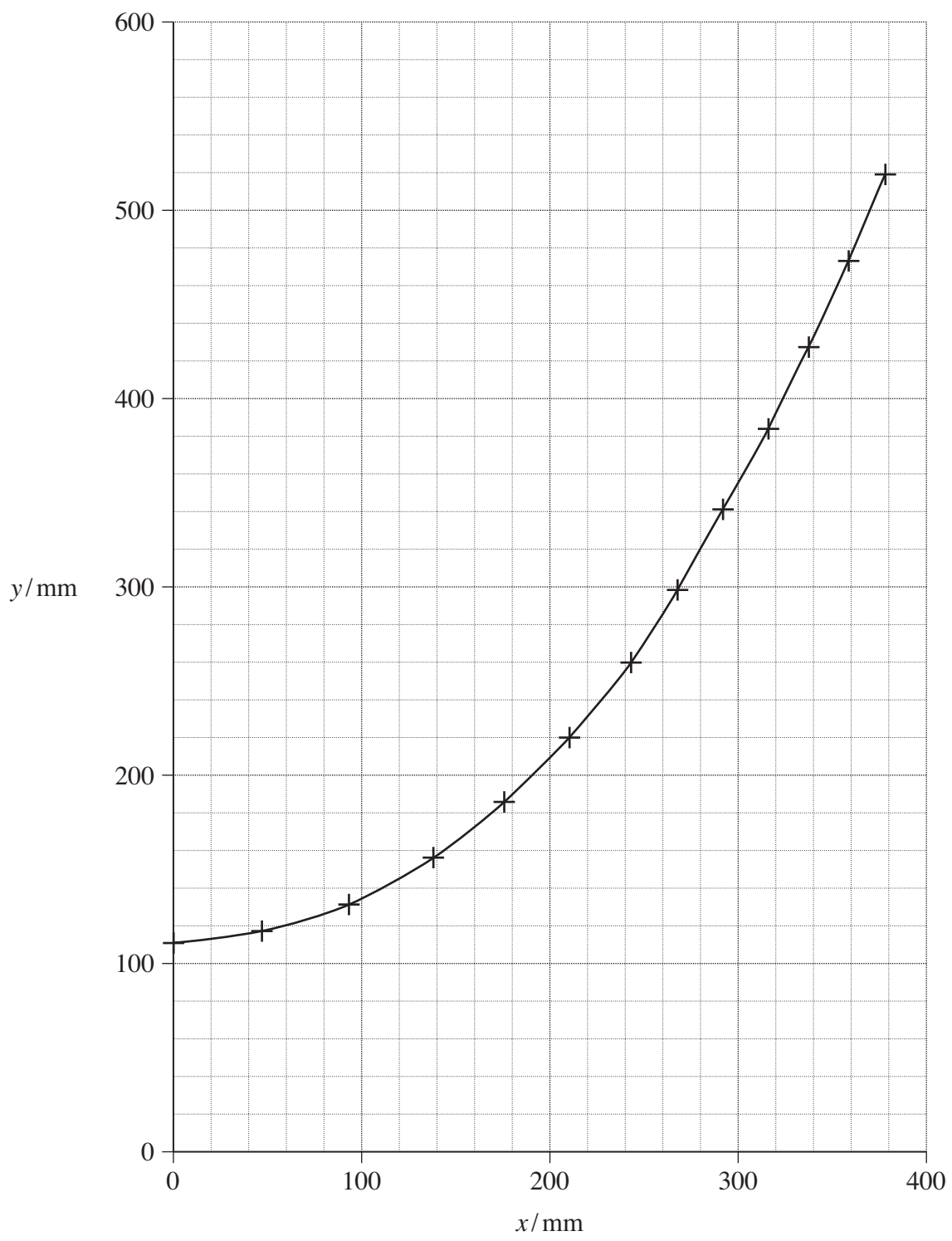

**Turn over for the next question**

**Turn over ►**

- 3** In Section A Task 1 you measured the period,  $T$ , of an oscillating chain of paper clips.
- 3 (i)** Make a sketch to show how you used a fiducial mark (reference point) to reduce the uncertainty in your values of  $T$ .

- 3 (ii)** Explain why you positioned the fiducial mark in the position shown in the sketch.

.....

.....

.....

(2 marks)

2

- 4 In Section A Task 1 you investigated the motion of coupled pendulums, measuring the time,  $\tau$ , for the amplitude of either pendulum to increase from zero to a maximum and then fall to zero again. A student performs this experiment and measures four values of  $\tau$  with three, five and then seven paper clips suspended from the thread. The student's results are shown in **Table 2**.

**Table 2**

$n$	$\tau_1/s$	$\tau_2/s$	$\tau_3/s$	$\tau_4/s$	mean $\tau/s$	uncertainty/s	percentage uncertainty
3	112.8	111.2	115.8	114.3			
5	67.3	69.9	64.2	66.2			
7	44.8	49.1	48.7	47.9			

- 4 (a) Complete the relevant column of **Table 2** to show the mean value of  $\tau$  for  $n = 3$ ,  $n = 5$  and  $n = 7$ .  
(1 mark)
- 4 (b) (i) Calculate the uncertainty in the mean values of  $\tau$  for  $n = 3$ ,  $n = 5$  and  $n = 7$ ; show the results of these calculations in the relevant column of **Table 2**.
- 4 (b) (ii) Use your results to calculate the percentage uncertainty in the mean values of  $\tau$  for  $n = 3$ ,  $n = 5$  and  $n = 7$ ; show the results of these calculations in the relevant column of **Table 2**.  
(2 marks)

Use this space for any working.

Question 4 continues on the next page

Turn over ►

- 4 (c) A student uses a motion sensor connected to a data logger to investigate the motion of one of the coupled pendulums. Data about the displacement,  $x$ , of the pendulum bob is recorded over an interval of 100 seconds and then displayed graphically, as shown in **Figure 5**.

**Figure 5**

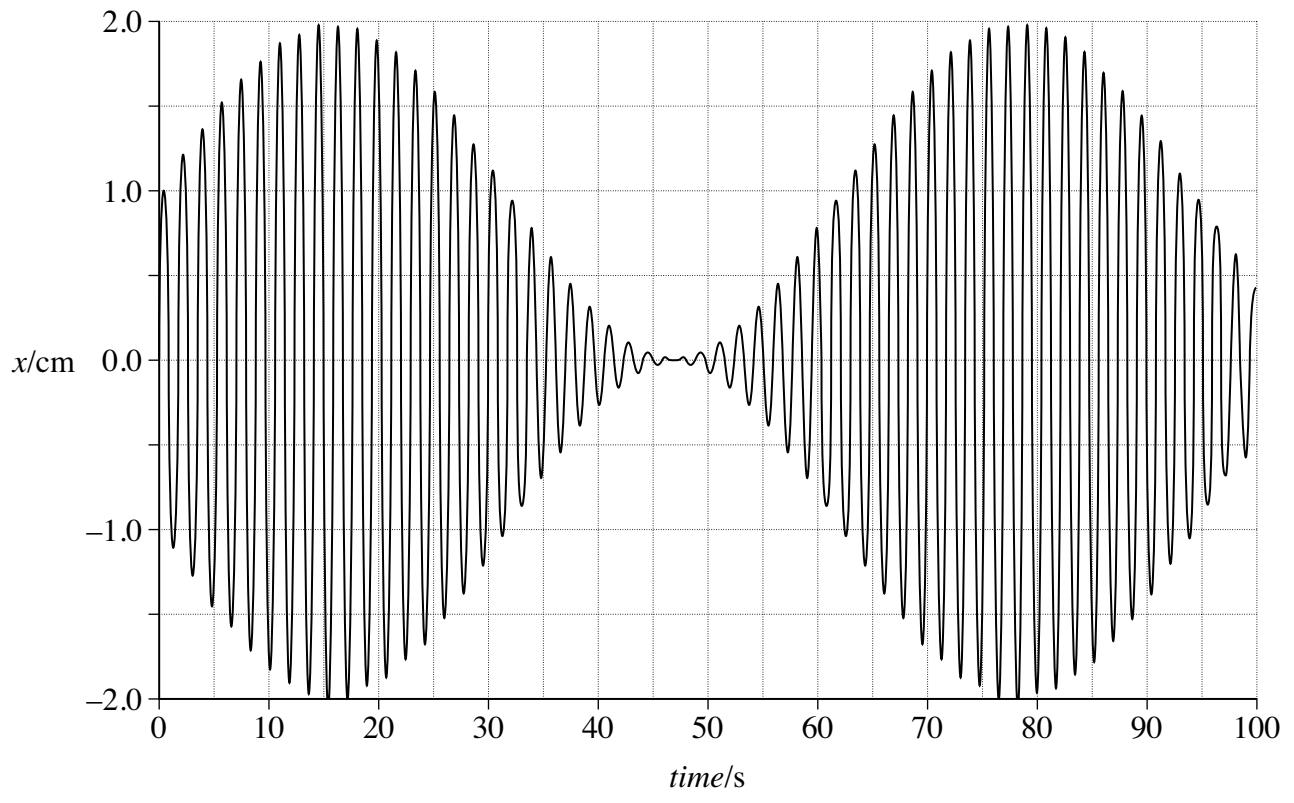

- 4 (c) (i) Use **Figure 5** to estimate  $\tau$  for these coupled pendulums.

.....  
 .....  
 $\tau =$  .....

- 4 (c) (ii) Determine the period of the pendulum's motion represented in **Figure 5**.

.....  
 .....  
 period = .....

(3 marks)



4 (d) State and explain **two** advantages of using a data logging technique to produce the data in an experiment such as this, compared with the method which you were required to use in Section A Task 1.

*advantage 1*

.....

.....

.....

.....

.....

.....

*advantage 2*

.....

.....

.....

.....

.....

.....

(4 marks)

<b>10</b>

**END OF QUESTIONS**



Centre Number						Candidate Number					
Surname						Other Names					
<b>Notice to Candidate.</b> The work you submit for assessment must be your own. If you copy from someone else or allow another candidate to copy from you, or if you cheat in any other way, you may be disqualified.											
<b>Candidate Declaration.</b> I have read and understood the Notice to Candidate and can confirm that I have produced the attached work without assistance other than that which is acceptable under the scheme of assessment.											
Candidate Signature						Date					

For Examiner's Use	
Examiner's Initials	
Section	Mark
Section A Part 1	
Section B Part 2	
Section B	
TOTAL	



General Certificate of Education  
Advanced Level Examination  
June 2011

# Physics (Specifications A and B)

## PHA6/B6/X

**Unit 6 Investigative and Practical Skills in A2 Physics**  
**Route X Externally Marked Practical Assignment (EMPA)**

### Section B Written Test

<p><b>For this paper you must have</b></p> <ul style="list-style-type: none"> <li>your completed Section A Part 2 question paper / answer booklet.</li> <li>a ruler</li> <li>a pencil</li> <li>a calculator.</li> </ul>	<p><b>Instructions</b></p> <ul style="list-style-type: none"> <li>Use black ink or black ball-point pen.</li> <li>Fill in the boxes at the top of this page.</li> <li>Answer <b>all</b> questions.</li> <li>You must answer the questions in the space provided. Do not write outside the box around each page or on blank pages.</li> <li>Show all your working.</li> <li>Do all rough work in this book. Cross through any work you do not want to be marked.</li> </ul>
<p><b>Time allowed</b></p> <ul style="list-style-type: none"> <li>1 hour 15 minutes</li> </ul>	<p><b>Information</b></p> <ul style="list-style-type: none"> <li>The marks for questions are shown in brackets.</li> <li>The maximum mark for this paper is 24.</li> </ul>
<p><b>Details of additional assistance (if any).</b> Did the candidate receive any help or information in the production of this work? If you answer yes, give the details below or on a separate page.</p> <p>Yes <input type="checkbox"/> No <input type="checkbox"/></p>	

<p><b>Practical Skills Verification</b></p> <p>Teacher Declaration: I confirm that the candidate has met the requirement of the practical skills verification (PSV) in accordance with the instructions and criteria in section 3.8 of the specification.</p>	<p>Yes <input type="checkbox"/></p>
---	-------------------------------------

Signature of teacher ..... Date .....

<p>As part of AQA's commitment to assist students, AQA may make your coursework available on a strictly anonymous basis to teachers, examining staff and students in paper form or electronically, through the Internet or other means, for the purpose of indicating a typical mark or for other educational purposes. In the unlikely event that your coursework is made available for the purposes stated above, you may object to this at any time and we will remove the work on reasonable notice. If you have any concerns please contact AQA.</p> <p>To see how AQA complies with the Data Protection Act 1988 please see our Privacy Statement at <a href="http://aqa.org.uk">aqa.org.uk</a>.</p>
--

## PHA6/B6/X

**Section B**

Answer **all** the questions in the spaces provided.

The time allowed is 1 hour 15 minutes.

You will need to refer to the work you did in Section A Part 2 when answering these questions.

- 1 (a) (i)** Determine the gradient,  $G$ , of your graph of  $\ln(V/mV)$  against  $Q$ .

.....  
 .....  
 .....

$$G = \dots\dots\dots$$

- 1 (a) (ii)** Read and record the vertical intercept from your graph.

vertical intercept = .....

(3 marks)

- 1 (b)** A student claims that an analogy can be made between the experiment in which light is absorbed by the ink solution and an experiment in which ionising radiation is absorbed by different thicknesses of metal plates.

Using the analogy, she suggests that the output voltage of the solar cell,  $V$ , is given by

$$V = Pe^{-\lambda Q},$$

where  $P$  and  $\lambda$  are constants.

- 1 (b) (i)** If the student's analogy is correct, describe the form that a graph of  $\ln(V/mV)$  against  $Q$  should take and explain how the values of  $P$  and  $\lambda$  may be deduced from the graph.

.....  
 .....  
 .....  
 .....  
 .....  
 .....

**1 (b) (ii)** Explain whether the qualitative and quantitative evidence obtained from your graph confirms the student's analogy.

.....

.....

.....

.....

.....

.....

.....

.....

.....

.....

(6 marks)

9
---

**Turn over for the next question**

- 2 (a) (i) Describe **one** difficulty you experienced when measuring the volume of the ink solution.

.....  
.....

- 2 (a) (ii) Explain **one** precaution you took to reduce the uncertainty when measuring the volume of ink solution in the measuring cylinders.  
You may wish to use a sketch to illustrate your answer.

.....  
.....  
(2 marks)

- 2 (b) Having transferred between 90ml and 100 ml of ink solution to the beaker, students A and B did not follow the instructions about which measuring cylinders they should then use.  
Student A used only the **larger** measuring cylinder (capacity 100 ml, 1 ml graduations).  
Student B used only the **smaller** measuring cylinder (capacity 25 ml, 0.5 ml graduations).

- 2 (b) (i) Give a disadvantage of the procedure followed by student A.

.....  
.....

- 2 (b) (ii) Give a disadvantage of the procedure followed by student B.

.....  
.....  
(2 marks)

3 A student adapts the experiment to investigate how light is absorbed by glass. The student uses a varying number of glass microscope slides (up to a maximum of 20 slides) placed in a single stack on top of the solar cell to produce different thicknesses of the glass.

The student plots a graph of his results, as shown in **Figure 5**. Note that  $N$  = number of glass microscope slides placed on top of the solar cell.

**Figure 5**

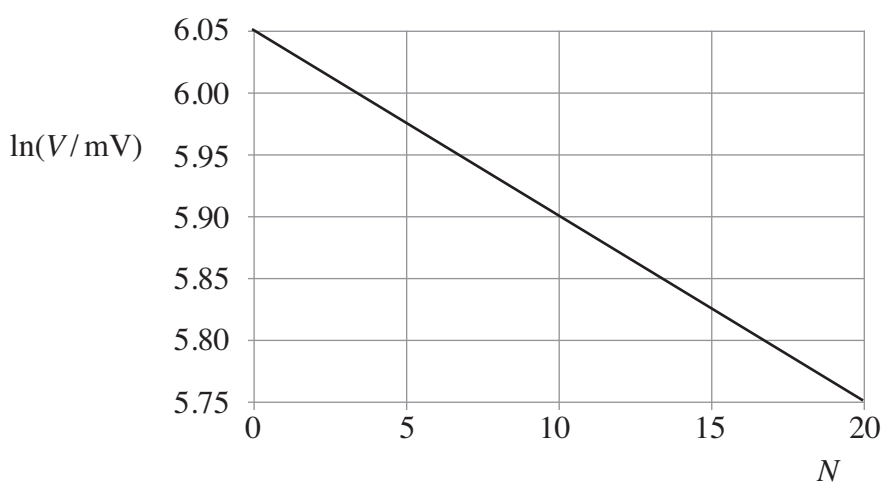

Assuming that the output voltage of the solar cell is directly proportional to the light intensity incident upon it, the student intends to determine the half-value thickness of glass, i.e. the thickness of glass that would reduce the output voltage by half.

3 (a) Use the information provided in the student's graph to calculate  $N_{0.5}$ , the value of  $N$  equivalent to the half-value thickness of the glass.

.....

.....

.....

.....

.....

.....

.....

.....

.....

(3 marks)

3 (b) To determine the half-value thickness of the glass in mm, the student needs to make one additional measurement.

3 (b) (i) Identify the measurement the student needs to make and explain how this is used to determine the half-value thickness of the glass.

.....  
.....  
.....  
.....

The student uses a micrometer screw gauge to make the additional measurement.

3 (b) (ii) Identify **one** procedure that can be used to reduce the effect of random errors when making the measurement.

.....  
.....  
.....  
.....

3 (b) (iii) Identify **one** procedure that can be used to detect, and hence correct, for possible systematic errors in the measurements made with the micrometer screw gauge.

.....  
.....  
.....  
.....

(3 marks)

          
**6**



- 4 The student uses a travelling microscope to learn more about the properties of the glass slides.

The eyepiece of the microscope is arranged to move vertically up or down above a scrap of newspaper showing a photograph.

The photograph is composed of dots which are only clearly visible when viewed through the microscope. By adjusting the position of the microscope the student brings the dots into focus and then reads the position of the microscope,  $R_0$ , using the vernier scale.

The student then places a stack of 12 slides over the photograph and refocuses the microscope. She records the new reading,  $R_1$ .

Finally, she places the photograph on top of the slides, refocuses the microscope, and records the new reading  $R_2$ .

The sequence of operations is illustrated in **Figure 6**.

**Figure 6**

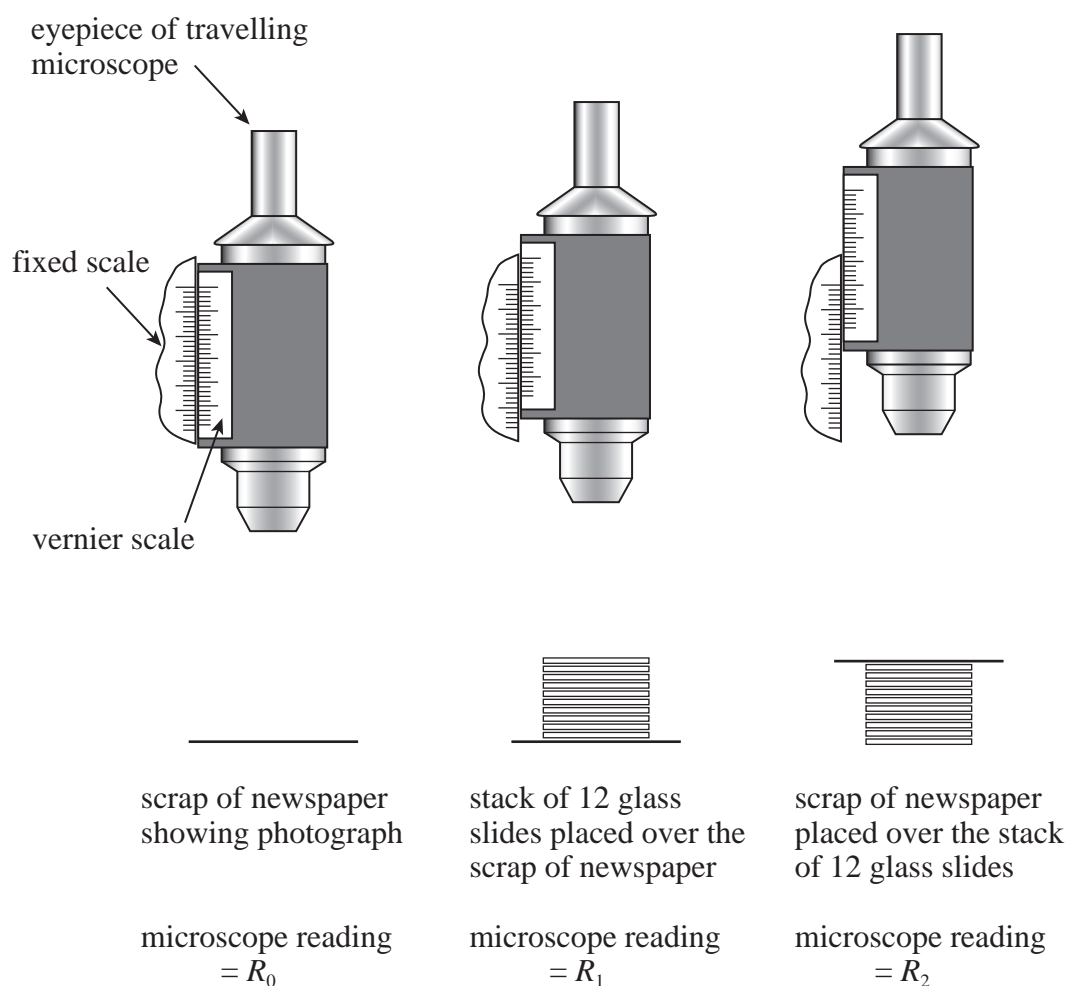

The readings made by the student are shown in the table below.

$R_0$ / mm	$R_1$ / mm	$R_2$ / mm
<b>2.74</b>	<b>7.31</b>	<b>17.02</b>

- 4 (a) Assuming that the slides have identical dimensions, use the readings to determine the thickness of one glass microscope slide.

.....  
 .....  
 (1 mark)

- 4 (b) Determine  $n$ , the refractive index of the glass, given by  $n = \frac{R_2 - R_0}{R_2 - R_1}$ .

.....  
 .....  
 (1 mark)

- 4 (c) The uncertainty in each of the readings  $R_0$ ,  $R_1$  and  $R_2$ , is 0.04 mm.

- 4 (c) (i) State the uncertainty in  $R_2 - R_0$ .

.....

- 4 (c) (ii) State the uncertainty in  $R_2 - R_1$ .

.....

- 4 (c) (iii) Hence calculate the percentage uncertainty in  $n$ .

.....  
 .....  
 .....  
 .....  
 .....  
 .....

(3 marks)

5
---

**END OF SECTION B**

Centre Number						Candidate Number					
Surname						Other Names					
<b>Notice to Candidate.</b> The work you submit for assessment must be your own. If you copy from someone else or allow another candidate to copy from you, or if you cheat in any other way, you may be disqualified.											
<b>Candidate Declaration.</b> I have read and understood the Notice to Candidate and can confirm that I have produced the attached work without assistance other than that which is acceptable under the scheme of assessment.											
Candidate Signature						Date					

For Examiner's Use	
Examiner's Initials	
Section	Mark
Section A Part 1 Q1	
Section A Part 1 Q2	
Section A Part 2 Q1	
Section B Q1	
Section B Q2	
Section B Q3	
Section B Q4	
TOTAL	



General Certificate of Education  
Advanced Level Examination  
June 2012

# Physics (Specifications A and B)

## PHA6/B6/X

**Unit 6 Investigative and Practical Skills in A2 Physics**  
**Route X Externally Marked Practical Assignment (EMPA)**

### Section B Written Test

<p><b>For this paper you must have</b></p> <ul style="list-style-type: none"> <li>your completed Section A Part 2 question paper / answer booklet.</li> <li>a ruler</li> <li>a pencil</li> <li>a calculator.</li> </ul>	<p><b>Instructions</b></p> <ul style="list-style-type: none"> <li>Use black ink or black ball-point pen.</li> <li>Fill in the boxes at the top of this page.</li> <li>Answer <b>all</b> questions.</li> <li>You must answer the questions in the space provided. Do not write outside the box around each page or on blank pages.</li> <li>Show all your working.</li> <li>Do all rough work in this book. Cross through any work you do not want to be marked.</li> </ul>
<p><b>Time allowed</b></p> <ul style="list-style-type: none"> <li>1 hour 15 minutes</li> </ul>	<p><b>Information</b></p> <ul style="list-style-type: none"> <li>The marks for questions are shown in brackets.</li> <li>The maximum mark for this paper is 23.</li> </ul>
<p><b>Details of additional assistance (if any).</b> Did the candidate receive any help or information in the production of this work? If you answer yes, give the details below or on a separate page.</p> <p>Yes <input type="checkbox"/> No <input type="checkbox"/></p>	

<p><b>Practical Skills Verification</b> Teacher Declaration: I confirm that the candidate has met the requirement of the practical skills verification (PSV) in accordance with the instructions and criteria in section 3.8 of the specification.</p>	<p>Yes <input type="checkbox"/></p>
--	-------------------------------------

Signature of teacher ..... Date .....

As part of AQA's commitment to assist students, AQA may make your coursework available on a strictly anonymous basis to teachers, examining staff and students in paper form or electronically, through the Internet or other means, for the purpose of indicating a typical mark or for other educational purposes. In the unlikely event that your coursework is made available for the purposes stated above, you may object to this at any time and we will remove the work on reasonable notice. If you have any concerns please contact AQA.

To see how AQA complies with the Data Protection Act 1988 please see our Privacy Statement at [aqa.org.uk](http://aqa.org.uk).

## PHA6/B6/X

**Section B**

Answer **all** the questions in the spaces provided.

You will need to refer to the work you did in Section A Part 2 when answering these questions.

- 1 (a) (i)** Determine the gradient,  $G$ , of your graph of  $\frac{R}{R+R_0}$  against  $T$ .

.....  
 .....  
 .....

$$G = \dots\dots\dots$$

(2 marks)

- 1 (a) (ii)** Calculate  $GT_0$ .

.....

$$GT_0 = \dots\dots\dots$$

(2 marks)

- 1 (b)** When no resistor is connected between clip P and clip Q, the time,  $T$ , for the voltmeter reading to fall by 50% =  $T_0$ .

- 1 (b) (i)** State the value of  $R$  when  $T = T_0$ .

.....

(1 mark)

- 1 (b) (ii)** Explain how  $T_0$  could be obtained from your graph of  $\frac{R}{R+R_0}$  against  $T$ .

.....  
 .....  
 .....  
 .....

(1 mark)

**Turn over for the next question**

6
---

**Turn over** ►

- 2 A student carried out the experiment on Section A Part 2, making measurements to determine the time,  $T$ , for the voltmeter reading to fall by 50% for different values of  $R$ , including smaller values than you used. The digital voltmeter used by the student had certain characteristics that may have introduced uncertainty in the measurements of  $T$ .

- 2 (a) The first characteristic is the *sample rate*; this is the rate at which readings are transferred to the display of the meter. For the type of digital voltmeter used, a typical sample rate is 2 Hz.

**Figure 6** shows how the voltmeter reading varied with time as the capacitor was discharged.

**Figure 6**

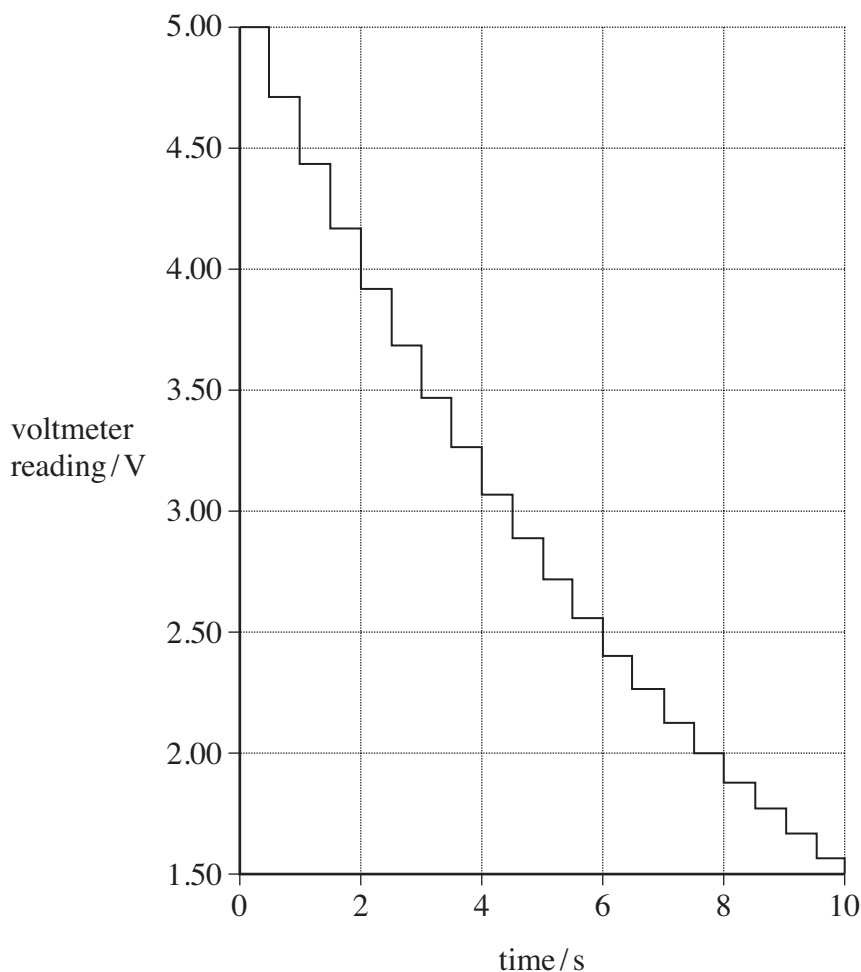

- 2 (a) (i) Explain how **Figure 6** shows that the sample rate of the voltmeter is 2 Hz.

.....

.....

(1 mark)

2 (a) (ii) With reference to **Figure 6**, outline **one** difficulty that the student would find when measuring  $T$  using the readings displayed on the voltmeter.

.....

.....

.....

.....

.....

.....

(2 marks)

2 (a) (iii) A teacher suggests that the student should wait until the voltmeter reading has fallen by 75% before stopping the watch. Explain how the value of  $T$  can be obtained using this method and explain why the uncertainty in the result would be reduced.

.....

.....

.....

.....

.....

.....

.....

.....

.....

.....

(2 marks)

**Question 2 continues on the next page**

A different student replaced the digital voltmeter with a voltage sensor connected to a data logger. The results of this experiment are shown in **Figure 7**.

**Figure 7**

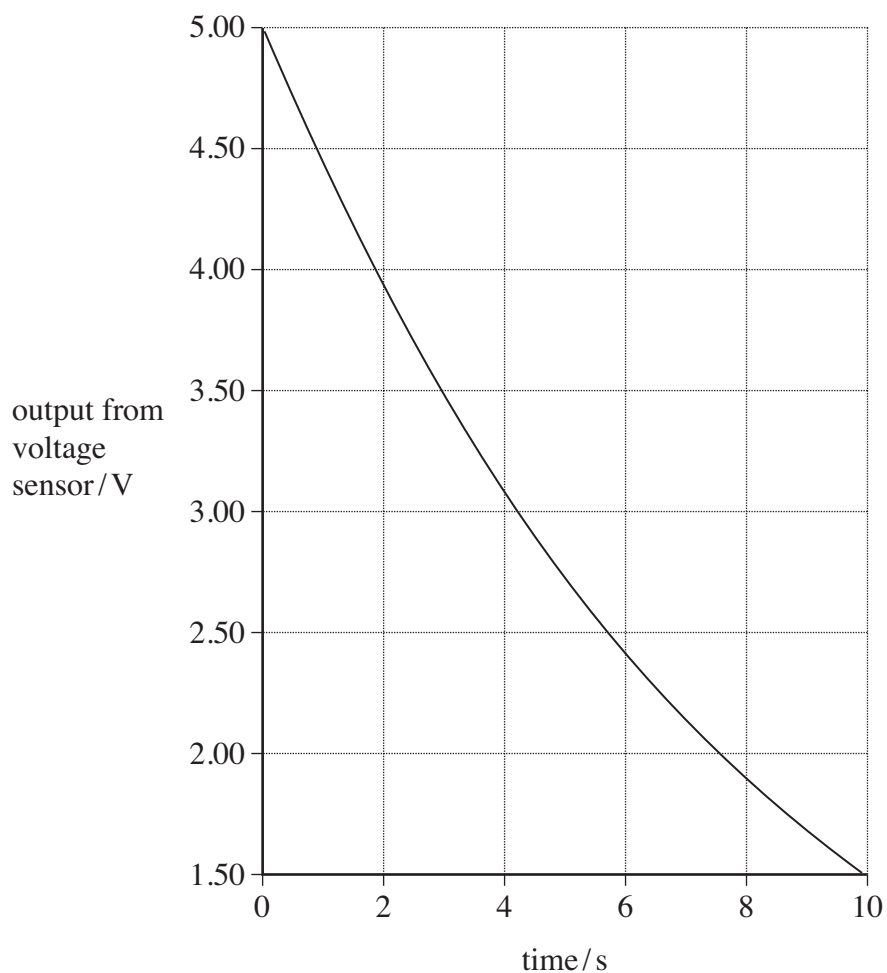

- 2 (a) (iv) Explain why the results displayed in **Figure 7** show a continuous curve whereas those represented in **Figure 6** show a stepped line.

.....

.....

(1 mark)

2 (b) The second characteristic of the meter that affects the measurements of  $T$  is the *resistance of the voltmeter*. The voltmeter provides another conducting route through which the capacitor can discharge, effectively lowering the resistance of the circuit. This causes all the readings of  $T$  to be less than they should have been.

2 (b) (i) What type of error does this cause in your measurements for  $T$ ?

.....

(1 mark)

**Figure 8** illustrates how the resistance of the voltmeter affects the experiment.

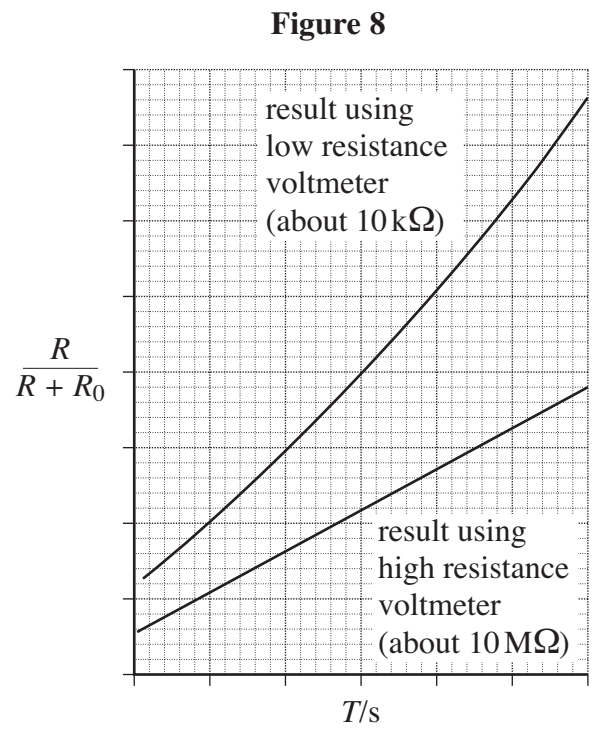

2 (b) (ii) Explain with reference to **Figure 8** whether the results of your experiment indicate that the resistance of the voltmeter you used was small enough to cause an error of this type.

.....

.....

.....

.....

(1 mark)

8
---

**Turn over for next question**

**Turn over** ►



- 3 In the experiment in Section A Part 1 you made measurements to calculate the radii of curvature of the surfaces of a spherical mirror. In order to check the accuracy of such an experiment, an instrument called a *spherometer* is used.

A spherometer is shown in **Figure 9**.

**Figure 9**

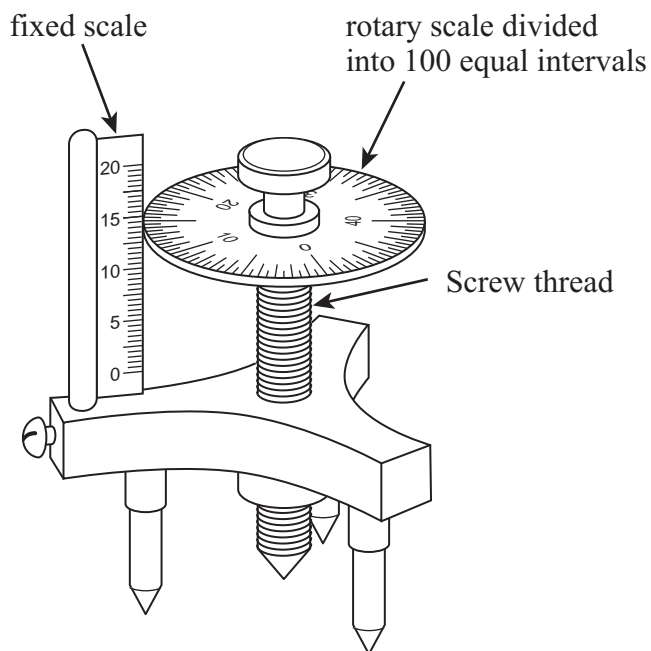

A spherometer, like a micrometer screw gauge, is a device in which a screw thread mechanism is used. One full rotation of the mechanism advances the screw 0.5 mm and this causes the rotary scale, which is divided into 100 equal intervals, to move vertically through one division of the fixed scale.

As with the micrometer screw gauge, the instrument is read by combining the readings from the fixed scale and the rotary scale.

- 3 (i) What is the precision of the spherometer?

.....  
(1 mark)

- 3 (ii) Measurements made with a spherometer show that the radius of curvature,  $R_2$ , of the convex surface of the mirror is 84.4 mm. Using the oscillating metre ruler method, a student calculates a value of  $R_2$  which is 4.5% lower than the spherometer value. Calculate the value of  $R_2$  obtained by the student.

.....

.....

.....

.....

(1 mark)

- 3 (iii) To calculate the radius of curvature,  $R_2$ , of the convex surface of the mirror, the student used the formula

$$R_2 \approx \frac{1}{3g} \left( \frac{x\pi}{T} \right)^2$$

in which  $x$  = the length of the ruler,  $g = 9.81 \text{ N kg}^{-1}$  and  $T$  is the period of the oscillations.

Assuming the uncertainties in  $x$  and  $g$  are negligible and the percentage uncertainty in  $R_2 = 4.5\%$ , calculate the percentage uncertainty in the student's result for  $T$ .

.....

.....

.....

.....

(1 mark)

- 3 (iv) Based on a single measurement of 10 oscillations, the student calculated that  $T = 2.04 \text{ s}$ . Calculate the uncertainty in the student's measurement for the time of 10 oscillations of the ruler.

.....

.....

.....

.....

(1 mark)

**Turn over for next question**

- 4 It is suggested to a student who is watching a metre ruler oscillating on the convex surface of a mirror that the amplitude of the oscillations decreases exponentially. The student is challenged to show whether or not this is true.

The student decides to record the motion of the ruler using a video camera. She attaches a pin to the end of the ruler and positions a vertical scale behind the tip of the pin, as shown in **Figure 10**.

**Figure 10**

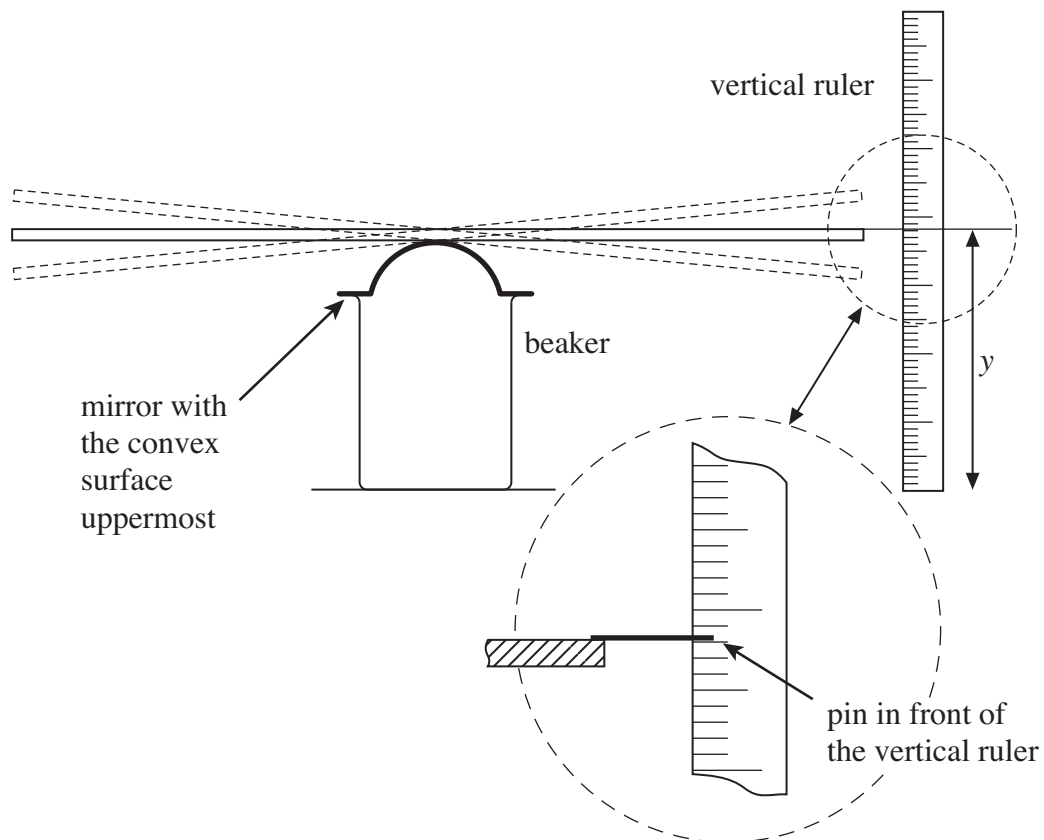

The student records the height above the bench of the tip of the pin at the top,  $y_t$ , and at the bottom,  $y_b$ , of its motion during several successive swings,  $n$ , of the ruler.

Her results are shown below.

$n$	0	1.5	3.0	4.5	6.0	7.5	9.0	10.5	12.0	13.5
$y_t/\text{cm}$	24.9		22.3		20.5		19.1		18.2	
$y_b/\text{cm}$		7.9		10.1		11.7		12.8		13.6

4 (a) Her data points are plotted on **Figure 11**.

**Figure 11**

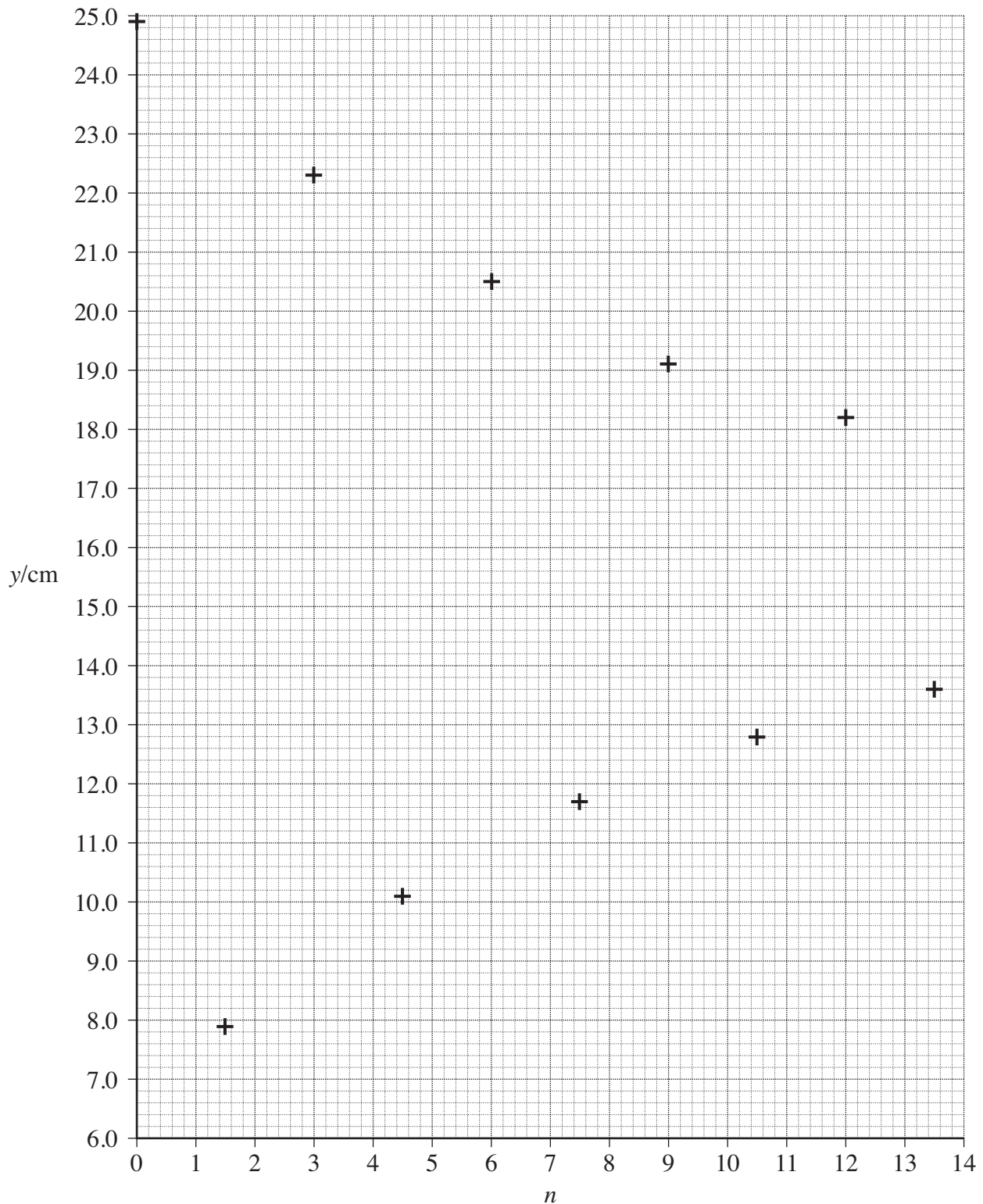

On **Figure 11** draw

- a line to show how  $y_t$  varies with  $n$ ,
- a line to show how  $y_b$  varies with  $n$ ,
- a line parallel to the horizontal axis to mark the position of the tip of the pin against the vertical scale when the ruler is at the equilibrium position.

(2 marks)

Turn over ►

4 (b) Hence or otherwise, explain whether the student's data confirms the suggestion that the amplitude of the oscillations decreases exponentially.

.....

.....

.....

.....

.....

.....

.....

.....

.....

.....

.....

.....

.....

.....

.....

.....

.....

(3 marks)

5
---

**END OF QUESTIONS**



Centre Number						Candidate Number					
Surname						Other Names					
<b>Notice to Candidate.</b> The work you submit for assessment must be your own. If you copy from someone else or allow another candidate to copy from you, or if you cheat in any other way, you may be disqualified.											
<b>Candidate Declaration.</b> I have read and understood the Notice to Candidate and can confirm that I have produced the attached work without assistance other than that which is acceptable under the scheme of assessment.											
Candidate Signature						Date					

For Examiner's Use	
Examiner's Initials	
Section	Mark
Section A Task 1 Q1	
Section A Task 1 Q2	
Section A Task 2 Q1	
Section B Q1	
Section B Q2	
Section B Q3	
TOTAL	



General Certificate of Education  
Advanced Level Examination  
June 2013

# Physics (Specifications A and B)

## PHA6/B6/X

**Unit 6 Investigative and Practical Skills in A2 Physics**  
**Route X Externally Marked Practical Assignment (EMPA)**

### Section B Written Test

<p><b>For this paper you must have:</b></p> <ul style="list-style-type: none"> <li>your completed Section A Task 2 question paper / answer booklet.</li> <li>a ruler</li> <li>a pencil</li> <li>a calculator.</li> </ul>	<p><b>Instructions</b></p> <ul style="list-style-type: none"> <li>Use black ink or black ball-point pen.</li> <li>Fill in the boxes at the top of this page.</li> <li>Answer <b>all</b> questions.</li> <li>You must answer the questions in the space provided. Do not write outside the box around each page or on blank pages.</li> <li>Show all your working.</li> <li>Do all rough work in this book. Cross through any work you do not want to be marked.</li> </ul>
<p><b>Time allowed</b></p> <ul style="list-style-type: none"> <li>1 hour 15 minutes</li> </ul>	<p><b>Information</b></p> <ul style="list-style-type: none"> <li>The marks for questions are shown in brackets.</li> <li>The maximum mark for this paper is 23.</li> </ul>
<p><b>Details of additional assistance (if any).</b> Did the candidate receive any help or information in the production of this work? If you answer yes, give the details below or on a separate page.</p> <p>Yes <input type="checkbox"/> No <input type="checkbox"/></p>	

<p><b>Practical Skills Verification</b> Teacher Declaration: I confirm that the candidate has met the requirement of the practical skills verification (PSV) in accordance with the instructions and criteria in section 3.8 of the specification.</p>	<p>Yes <input type="checkbox"/></p>
--	-------------------------------------

Signature of teacher ..... Date .....

As part of AQA's commitment to assist students, AQA may make your coursework available on a strictly anonymous basis to teachers, examining staff and students in paper form or electronically, through the Internet or other means, for the purpose of indicating a typical mark or for other educational purposes. In the unlikely event that your coursework is made available for the purposes stated above, you may object to this at any time and we will remove the work on reasonable notice. If you have any concerns please contact AQA.

To see how AQA complies with the Data Protection Act 1988 please see our Privacy Statement at [aqa.org.uk](http://aqa.org.uk).

## PHA6/B6/X

**Section B**

Answer **all** the questions in the spaces provided. Time allowed 1 hour 15 minutes.

You will need to refer to the work you did in Section A Task 2 when answering these questions.

- 1 (a)** Determine the gradient,  $G$ , of your graph of  $\log \left( \frac{1}{T^2} - \frac{1}{T_0^2} \right)$  against  $\log d$ .

.....  
 .....  
 .....

$$G = \dots\dots\dots$$

(4 marks)

- 1 (b)** It is suggested that the period is related to the distance by the expression

$$\frac{1}{T^2} - \frac{1}{T_0^2} = kd^n,$$

where  $k$  is a constant and  $n$  is an integer.

- 1 (b) (i)** Deduce the value of  $n$ .

$$n = \dots\dots\dots$$

- 1 (b) (ii)** Deduce the unit for  $k$ .

.....  
 .....  
 .....

- 1 (b) (iii)** State and explain how you could use your graph to deduce the numerical value of  $k$ .

.....  
 .....  
 .....  
 .....  
 .....  
 .....  
 .....

(4 marks)



- 2 In Section A Task 1 you observed the energy transfer between masses  $M_3$  and  $M_4$  suspended by springs from a horizontal metre ruler using the apparatus shown in **Figure 7**.

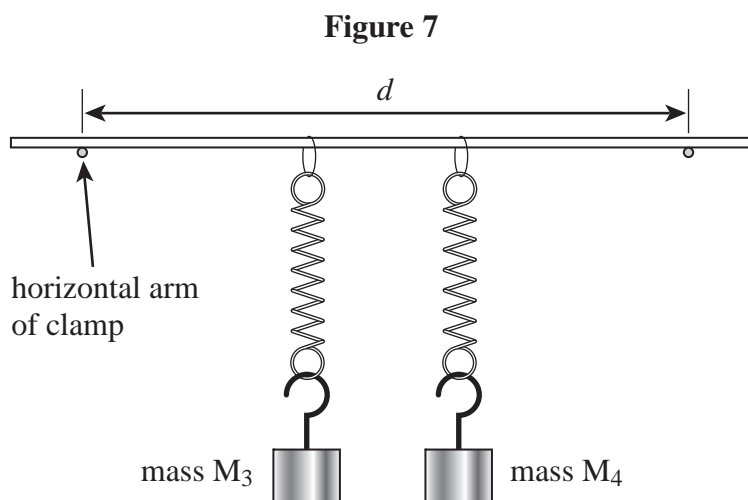

With the same apparatus, a student investigates how  $d$ , the horizontal distance between the arms of the clamps on which the metre ruler is supported, affects  $\tau$ , the time of energy transfer between  $M_3$  and  $M_4$ .

The student measured the times for  $n$  energy transfers between the masses, as shown in **Table 2**.

**Table 2**

$d/\text{cm}$	$n$	$n\tau/\text{s}$	$n\tau/\text{s}$	$\tau/\text{s}$
86.0	6	212	209	
78.0	5	236	240	
70.0	6	408	*	
65.0	4	347	*	

\* only one set of readings of  $n\tau$  was completed for these values of  $d$

- 2 (a) (i) Complete **Table 2** to show the values for  $\tau$  that the student obtained.

- 2 (a) (ii) Justify the number of significant figures you have given for the values of  $\tau$ .

.....

.....

(2 marks)

**2 (b)** The student claimed that these results showed that  $\tau$  was directly proportional to  $\frac{1}{d^2}$ .  
Analyse the data in **Table 2** to show whether the student's claim is correct.

.....

.....

.....

.....

.....

.....

.....

.....

(2 marks)

**2 (c)** Suggest **three** valid control variables for the experiment.

1 .....

2 .....

3 .....

(1 mark)

**THE QUESTION IS CONTINUED ON THE NEXT PAGE**

- 2 (d) In a different experiment to illustrate energy transfer between oscillators, three bar magnets are arranged as shown in **Figure 8**.

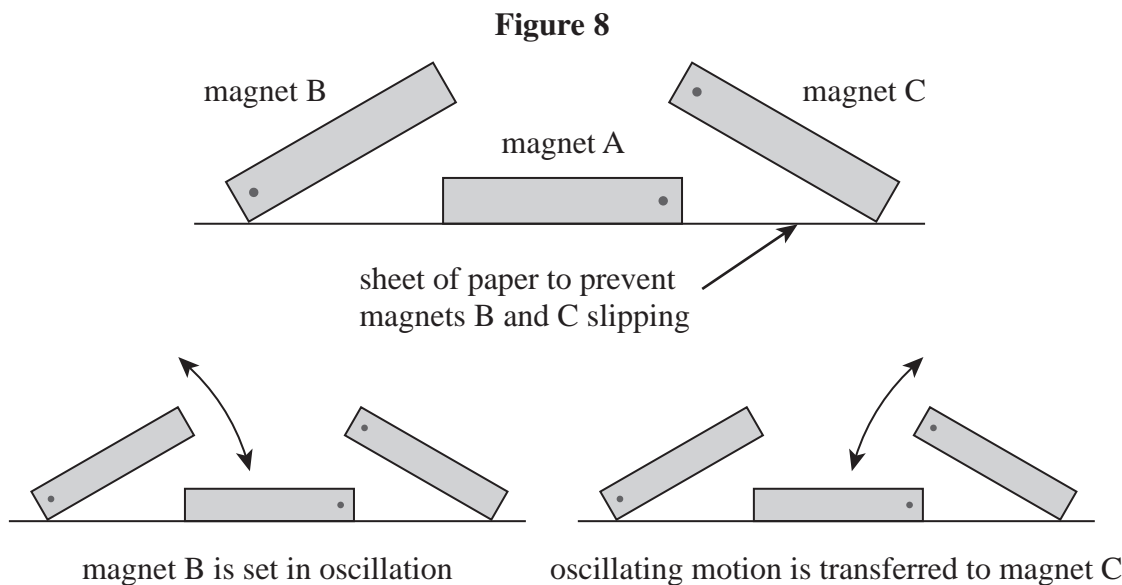

Magnets B and C are balanced on one edge using the repulsion produced by magnet A, the paper below providing friction to prevent B and C slipping.

When B is set oscillating about the point of contact with the paper, the oscillating motion is transferred within a few cycles to C, and then back again, as in your experiment with masses  $M_3$  and  $M_4$ .

A student uses a motion sensor and a data logger to record the motion of magnet B; the data are then exported to a computer and analysed using a spreadsheet.

**Figure 9** is based on 25000 measurements that are transferred to the data logger in 10 seconds and shows how the displacement,  $y$ , of the moving end of magnet B, varies with time,  $t$ .

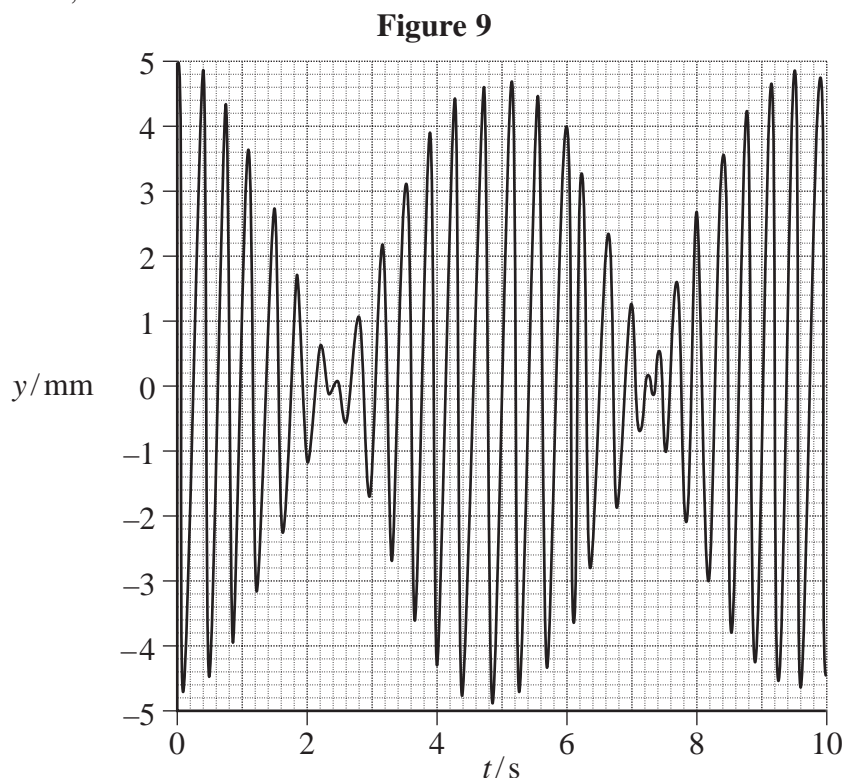

2 (d) (i) What was the *sample rate* of the data logger when the data displayed in **Figure 9** was being recorded?

sample rate = .....

The sample rate is then changed so that 25 000 measurements are transferred to the data logger in 250 seconds. These results are displayed in **Figure 10**.

**Figure 10**

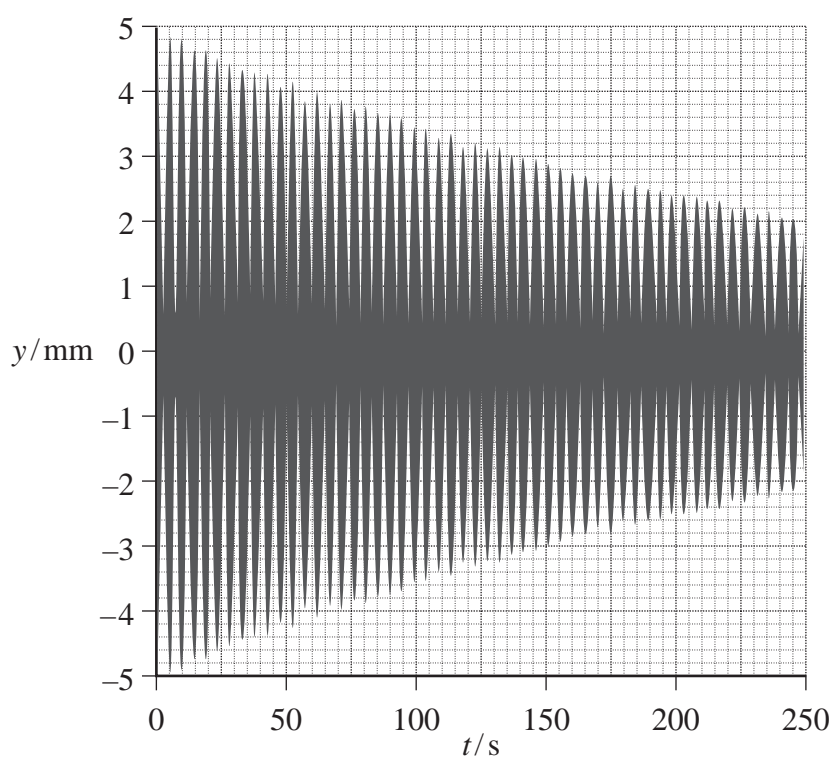

2 (d) (ii) If  $\tau$  = the time for energy transfer from magnet B to magnet C and back again to B, and  $T$  = the period of oscillations of magnet B, use **Figure 9** and **Figure 10** to determine  $\frac{\tau}{T}$ .

You may assume that in both **Figure 9** and **10**,  $y$  has just reached a maximum value at  $t = 0$ .

.....  
 .....  
 .....  
 .....

$\frac{\tau}{T} = \dots\dots\dots$  (4 marks)

- 3 In Section A Task 1 you used a compass to investigate how the magnetic flux density varies between two bar magnets. One magnet was positioned on a metre ruler, aligned east-west, and the other on a half-metre ruler, aligned north-south. A student, performing this experiment, sees that when the magnet on the half-metre ruler is removed the compass needle rotates through an angle  $\theta$ , as shown in **Figure 11**. The student notices that when the remaining magnet is moved along the metre ruler so that the distance  $x$  defined in **Figure 11**, is reduced,  $\theta$  increases.

**Figure 11**

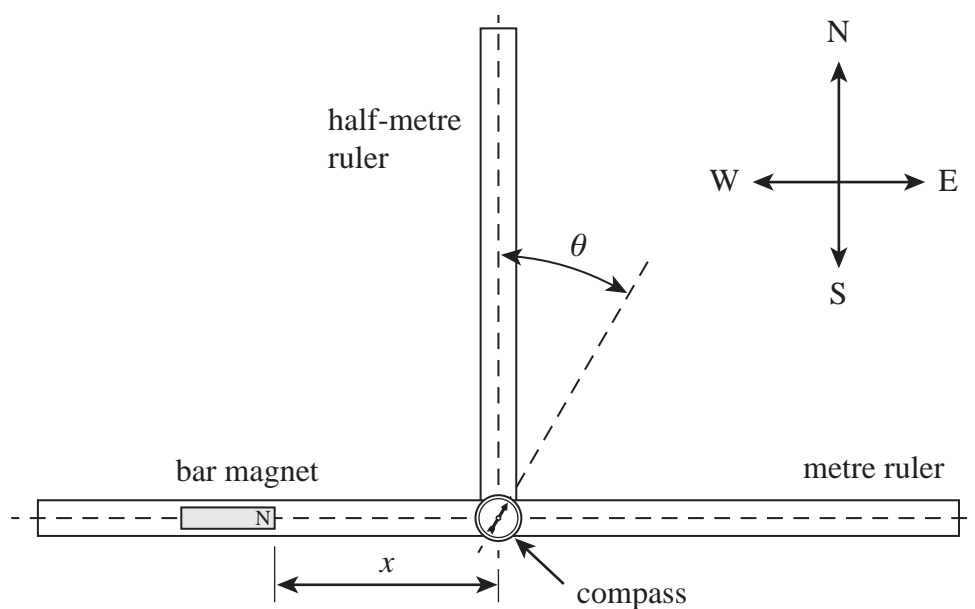



- 3 (b) The teacher shows the student an instrument called a deflection magnetometer and suggests that this could be used in place of the compass to reduce uncertainty in the measurement of  $\theta$ .

A deflection magnetometer, as seen from above, is shown in **Figure 12** and consists of a magnet pivoted at the centre of a rotary scale. A long pointer is mounted at right angles to the magnet and a mirror is set into the dial. A plotting compass is shown to the same scale so a comparison can be made with the size of the magnetometer.

**Figure 12**

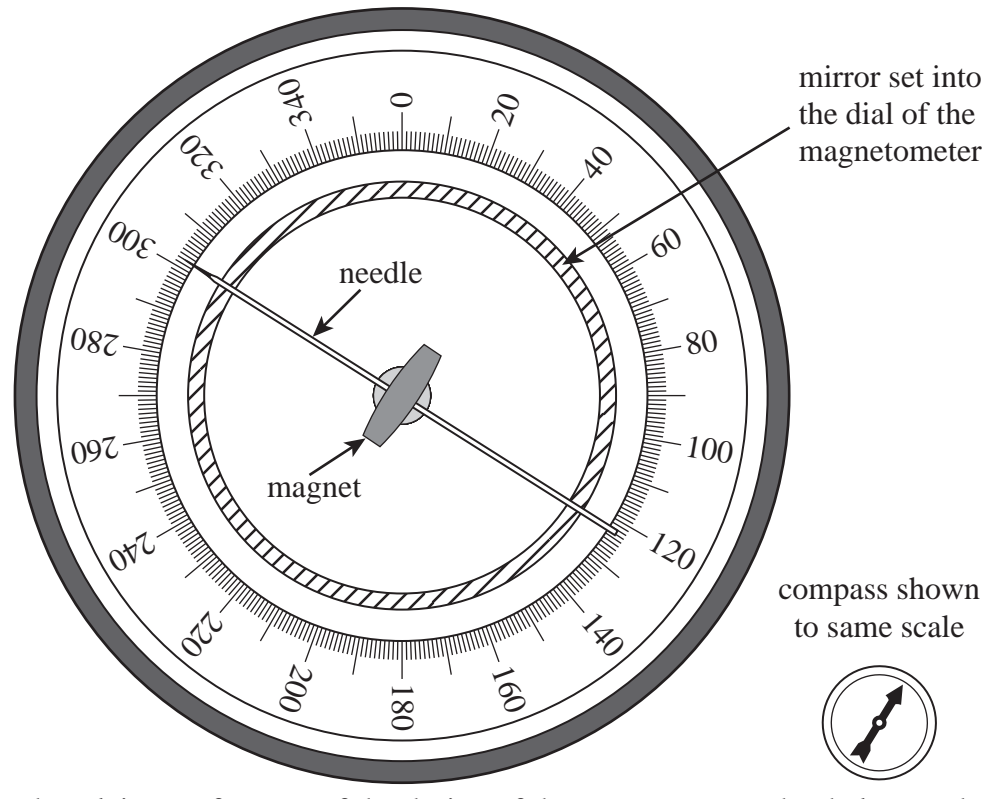

State and explain two features of the design of the magnetometer that help to reduce uncertainty in the measurement of  $\theta$ .

first feature:

.....

.....

.....

second feature:

.....

.....

.....

(3 marks)

**END OF QUESTIONS**